



TEST REPORT

Report Number..... : **ZKT-2605110086E**

Date of Test..... : May. 11, 2026 to May. 15, 2026

Date of issue..... : May. 15, 2026

Total number of pages..... : 34

Test Result : PASS

Testing Laboratory..... : **Shenzhen ZKT Technology Co., Ltd.**

Address : 1/F, No. 101, Building B, No. 6, Tangwei Community Industrial Avenue,
Fuhai Street, Bao'an District, Shenzhen, China.

Applicant's name : **AS COMPANY EUROPA S.O.O**

Address : Poland, Katowice, Bażantów street 35/6

Manufacturer's name : **Yiwu Xiqi Trading Co., Ltd**

Address : 6th Floor, Building E, No. 452, Jingfa Avenue, Beiyuan Sub-district,
Yiwu City, Jinhua City, China (Zhejiang) Pilot Free Trade Zone

Test specification:

Standard..... : EN IEC 55014-1:2021, EN IEC 55014-2:2021
EN IEC 61000-3-2:2019/A1:2021/A2:2024,
EN 61000-3-3:2013/A1:2019/A2:2021

Test procedure..... : CE-EMC

Non-standard test method : N/A

Test Report Form No..... : TRF-EL-142_V0

Test Report Form(s) Originator..... : ZKT Testing

Master TRF : Dated: 2020-01-06

This device described above has been tested by ZKT, and the test results show that the equipment under test (EUT) is in compliance with the 2014/30/EU Directive requirements. And it is applicable only to the tested sample identified in the report.

This report shall not be reproduced except in full, without the written approval of ZKT, this document may be altered or revised by ZKT, personal only, and shall be noted in the revision of the document.

Product name..... : **Permanent Makeup Machine**

Trademark : N/A

Model/Type reference..... : Hero Hero2

Ratings..... : Input: DC 12V1A
Battery: 3.7V/1200mAh, 4.44Wh



Testing procedure and testing location:

Testing Laboratory.....: **Shenzhen ZKT Technology Co., Ltd.**
Address.....: 1/F, No. 101, Building B, No. 6, Tangwei Community
Industrial Avenue, Fuhai Street, Bao'an District,
Shenzhen, China

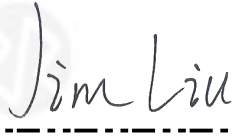
Tested by (name + signature).....: Jim Liu 

Reviewer (name + signature).....: Jackson Fang 

Approved (name + signature).....: Lake Xie 



TABLE OF CONTENT

	Page
1. VERSION	5
2. GENERAL INFORMATION	6
2.1 Description of Device (EUT)	6
2.2 Tested System Details	6
2.3 Test Facility	6
2.4 MEASUREMENT UNCERTAINTY	6
2.5 Test Instrument Used	7
3. CONDUCTED EMISSION AT THE MAINS TERMINALS TEST	7
3.1 Block Diagram Of Test Setup	9
3.2 Test Standard	9
3.3 Power Line Conducted Emission Limit	9
3.4 EUT Configuration on Test	9
3.5 Operating Condition of EUT	9
3.6 Test Procedure	9
3.7 Test Result	9
4. RADIATION EMISSION TEST	10
4.1 Block Diagram of Test Setup	10
4.2 Test Standard	10
4.3 Radiation Limit	10
4.4 EUT Configuration on Test	10
4.5 Operating Condition of EUT	10
4.6 Test Procedure	11
4.7 Test Result	11
5. HARMONIC CURRENT EMISSION TEST	14
5.1 Block Diagram of Test Setup	14
5.2 Test Standard	14
5.3 Operating Condition of EUT	14
5.4 Test Procedure	14
5.5 Test Results	14
6. VOLTAGE FLUCTUATIONS & FLICKER TEST	15
6.1 Block Diagram of Test Setup	15
6.2 Test Standard	15
6.3 Operating Condition of EUT	15
6.4 Test Procedure	15
6.5 Test Results	15
7. ELECTROSTATIC DISCHARGE IMMUNITY TEST	16
7.1 Block Diagram of Test Setup	16
7.2 Test Standard	16
7.3 Severity Levels and Performance Criterion	16
7.4 EUT Configuration	17
7.5 Operating Condition of EUT	17
7.6 Test Procedure	17
7.7 Test Results	17
8. RF FIELD STRENGTH SUSCEPTIBILITY TEST	19
8.1 Block Diagram of Test Setup	19
8.2 Test Standard	19
8.3 Severity Levels and Performance Criterion	19
8.4 EUT Configuration on Test	20
8.5 Operating Condition of EUT	20
8.6 Test Procedure	20
8.7 Test Results	20



9. ELECTRICAL FAST TRANSIENT/BURST IMMUNITY TEST	22
9.1 Block Diagram of EUT Test Setup	22
9.2 Test Standard	22
9.3 Severity Levels and Performance Criterion	22
9.4 EUT Configuration on Test	23
9.5 Operating Condition of EUT	23
9.6 Test Procedure	23
9.7 Test Results	23
10. SURGE TEST	24
10.1 Block Diagram of EUT Test Setup	24
10.2 Test Standard	24
10.3 Severity Levels and Performance Criterion	24
10.4 EUT Configuration on Test	25
10.5 Operating Condition of EUT	25
10.6 Test Procedure	25
10.7 Test Result	25
11. INJECTED CURRENTS SUSCEPTIBILITY TEST	26
11.1 Block Diagram of EUT Test Setup	26
11.2 Test Standard	26
11.3 Severity Levels and Performance Criterion	26
11.4 EUT Configuration on Test	26
11.5 Operating Condition of EUT	27
11.6 Test Procedure	27
11.7 Test Result	27
12. VOLTAGE DIPS AND INTERRUPTIONS TEST	28
12.1 Block Diagram of EUT Test Setup	28
12.2 Test Standard	28
12.3 Severity Levels and Performance Criterion	28
12.4 EUT Configuration on Test	29
12.5 Operating Condition of EUT	29
12.6 Test Procedure	29
12.7 Test Result	29
13. EUT PHOTOGRAPHS	30
14. EUT TEST PHOTOGRAPHS	34



1. VERSION

Report No.	Version	Description	Approved
ZKT-2605110086E	Rev.01	Initial issue of report	May. 15, 2026



2. GENERAL INFORMATION

2.1 Description of Device (EUT)

EUT : Permanent Makeup Machine
Trademark : N/A
Model Number : Hero Hero2
Model Difference : N/A
Power Supply : Input: DC 12V1A
Battery: 3.7V/1200mAh, 4.44Wh

The highest frequency of the internal sources of the EUT is (less than 108)MHz:
 less than 108 MHz, the measurement shall only be made up to 1 GHz.
 above 108 MHz, the measurement shall only be made up to 6 GHz.

Note: N/A

2.2 Tested System Details

None.

2.3 Test Facility

Shenzhen ZKT Technology Co., Ltd.
Add. : 1/F, No. 101, Building B, No. 6, Tangwei Community Industrial Avenue, Fuhai Street, Bao'an District, Shenzhen, China

FCC Test Firm Registration Number: 927491
Designation Number: CN1431
IC Registered No.: 27033

2.4 MEASUREMENT UNCERTAINTY

Where relevant, the following measurement uncertainty levels have been estimated for tests performed on the Product as specified in CISPR 16-4-2. This uncertainty represents an expanded uncertainty expressed at approximately the 95% confidence level using a coverage factor of k=2.

Test item	Value (dB)
Conducted Emission (150K-30MHZ)	3.20
Radiated disturbance30MHz-1000MHz	4.80



2.5 Test Instrument Used
Conduction Emissions Test

Item	Kind of Equipment	Manufacturer	Type No.	Serial No.	Firmware Version	Last calibration	Calibrated until
1	LISN	R&S	ENV216	101471	N/A	Sep. 23, 2025	Sep. 22, 2026
2	LISN	CYBERTEK	EM5040A	E1850400149	N/A	Sep. 19, 2025	Sep. 18, 2026
3	Test Cable	N/A	C-01	N/A	N/A	May. 25, 2025	May. 24, 2026
4	Test Cable	N/A	C-02	N/A	N/A	May. 25, 2025	May. 24, 2026
5	Test Cable	N/A	C-03	N/A	N/A	May. 25, 2025	May. 24, 2026
6	EMI Test Receiver	R&S	ESCI3	101393	4.42 SP3	Oct. 24, 2025	Oct. 23, 2026
7	Triple-Loop Antenna	N/A	RF300	9194	N/A	Sep. 19, 2025	Sep. 18, 2026
8	Absorbing Clamp	DZ	ZN23201	15034	N/A	Sep. 23, 2025	Sep. 22, 2026
9	EMC Software	Frad	EZ-EMC	Ver.EMC-CON 3A1.1	N/A	\	\

Harmonic / Flicker Test

Item	Kind of Equipment	Manufacturer	Type No.	Serial No.	Firmware Version	Last calibration	Calibrated until
1	Harmonic & Flicker	HTEC Instruments	AC2000A	548549	1.21	Sep. 19, 2025	Sep. 18, 2026
2	AC Power Source	/	HPHF4010	JN1022090795	DAL40	Sep. 19, 2025	Sep. 18, 2026

Electrostatic discharge Test

Item	Kind of Equipment	Manufacturer	Type No.	Serial No.	Firmware Version	Last calibration	Calibrated until
1	ESD TEST GENERATOR	HTEC	HESD16	/	004307	Sep. 19, 2025	Sep. 18, 2026

EFT and Surge and Voltage dips and interruptions Test

Item	Kind of Equipment	Manufacturer	Type No.	Serial No.	Firmware Version	Last calibration	Calibrated until
1	Surge Generator	HTEC	HCOMPACT5	202501	V1.3.4	Sep. 19, 2025	Sep. 18, 2026
2	DIPS Generator	HTEC	HV1P16T	202501	V1.3.4	Sep. 19, 2025	Sep. 18, 2026
3	EFT/B Generator	HTEC	HCOMPACT5	202501	V1.3.4	Sep. 19, 2025	Sep. 18, 2026
4	EFT/B Clamp	HTEC	H3C	/	N/A	Sep. 19, 2025	Sep. 18, 2026

For Magnetic Field Immunity Test

Item	Kind of Equipment	Manufacturer	Type No.	Serial No.	Firmware Version	Last calibration	Calibrated until
1	Generator	HTEC	HFMG 100	202602	V2.1-182802	Sep. 19, 2025	Sep. 18, 2026

Radio-frequency fields Immunity Test

Item	Kind of Equipment	Manufacturer	Type No.	Serial No.	Firmware Version	Last calibration	Calibrated until
1	Signal Generator	TESEQ	NSG4070-75	31477	V1.30	Sep. 19, 2025	Sep. 18, 2026
2	CDN	SCHWARZBECK	CDN M2/M3PE 16A	00128	N/A	Sep. 19, 2025	Sep. 18, 2026
3	Attenuator	GuoRenTong Xin	SGR-SJQ-6dB -DC-3	N/A	N/A	Sep. 19, 2025	Sep. 18, 2026



Radiation Emissions Test

Item	Equipment	Manufacturer	Type No.	Serial No.	Firmware Version	Last calibration	Calibrated until
1	Spectrum Analyzer (9kHz-26.5GHz)	KEYSIGHT	N9020A	MY55370835	A.17.05	Sep. 20, 2025	Sep. 19, 2026
2	Spectrum Analyzer (10kHz-39.9GHz)	R&S	FSV40-N	100363	1.71 SP2	Sep. 20, 2025	Sep. 19, 2026
3	EMI Test Receiver (9kHz-7GHz)	R&S	ESCI7	100969	4.32	Oct. 24, 2025	Oct. 23, 2026
4	Bilog Antenna (30MHz-1500MHz)	Schwarzbeck	VULB9168	00877	N/A	Sep. 20, 2025	Sep. 19, 2026
5	Horn Antenna (1GHz-18GHz)	Agilent	AH-118	071145	N/A	Sep. 20, 2025	Sep. 19, 2026
6	Horn Antenna (15GHz-40GHz)	A.H.System	SAS-574	588	N/A	Sep. 30, 2025	Sep. 29, 2026
7	Loop Antenna	TESEQ	HLA6121	58357	N/A	Sep. 20, 2025	Sep. 19, 2026
8	Amplifier (30-1000MHz)	EM Electronics	EM330 Amplifier	60747	N/A	Sep. 19, 2025	Sep. 18, 2026
9	Amplifier (1GHz-26.5GHz)	HuiPu	8449B	3008A00315	N/A	Sep. 19, 2025	Sep. 18, 2026
10	Amplifier (500MHz-40GHz)	QuanJuDa	DLE-161	097	N/A	Oct. 24, 2025	Oct. 23, 2026
11	Test Cable	N/A	R-01	N/A	N/A	May. 25, 2025	May. 24, 2026
12	Test Cable	N/A	R-02	N/A	N/A	May. 25, 2025	May. 24, 2026
13	Test Cable	N/A	R-03	N/A	N/A	May. 25, 2025	May. 24, 2026
14	D.C. Power Supply	LongWei	TPR-6405D	N/A	N/A	\	\
15	EMC Software	Frad	EZ-EMC	Ver.EMC-CO N 3A1.1	N/A	\	\
16	Turntable	MF	MF-7802BS	N/A	N/A	\	\
17	Antenna tower	MF	MF-7802BS	N/A	N/A	\	\



3. CONDUCTED EMISSION AT THE MAINS TERMINALS TEST

3.1 Block Diagram Of Test Setup

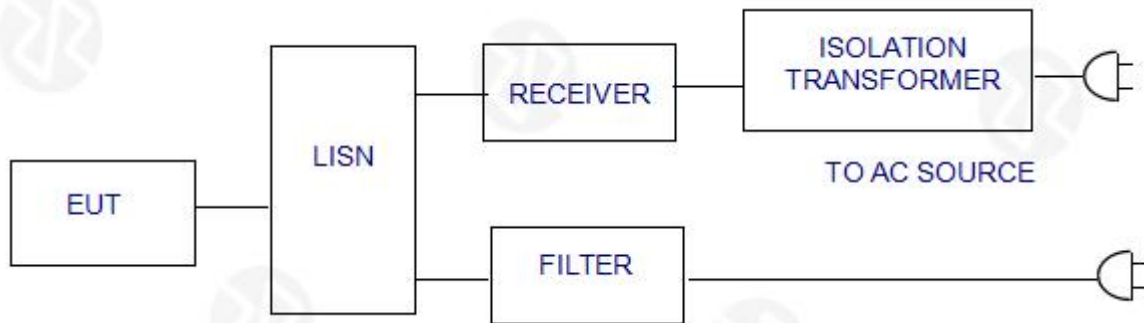

3.2 Test Standard

EN IEC 55014-1:2021

3.3 Power Line Conducted Emission Limit

Frequency MHz	Limits dB(μV)	
	Quasi-peak Level	Average Level
0.15 ~ 0.50	66 ~ 56*	59 ~ 46*
0.50 ~ 5.00	56	46
5.00 ~ 30.00	60	50

Notes: 1. *Decreasing linearly with logarithm of frequency.
2. The lower limit shall apply at the transition frequencies.

3.4 EUT Configuration on Test

The following equipments are installed on conducted emission test to meet EN IEC 55014-1 requirement and operating in a manner which tends to maximize its emission characteristics in a normal application.

3.5 Operating Condition of EUT

- 3.5.1 Setup the EUT and simulators as shown in Section 3.1.
- 3.5.2 Turn on the power of all equipments.
- 3.5.3 Let the EUT work in test modes and test it.

3.6 Test Procedure

The EUT is put on the ground and connected to the AC mains through a Artificial Mains Network (AMN). This provided a 50ohm coupling impedance for the tested equipments. Both sides of AC line are checked to find out the maximum conducted emission levels according to the **EN55014-1** regulations during conducted emission test.

The bandwidth of the test receiver (R&S Test Receiver ESCI) is set at 10KHz.

The frequency range from 150 KHz to 30 MHz is investigated.

3.7 Test Result

The EUT is powered by DC only. The test items is not applicable.



4. RADIATION EMISSION TEST

4.1 Block Diagram of Test Setup

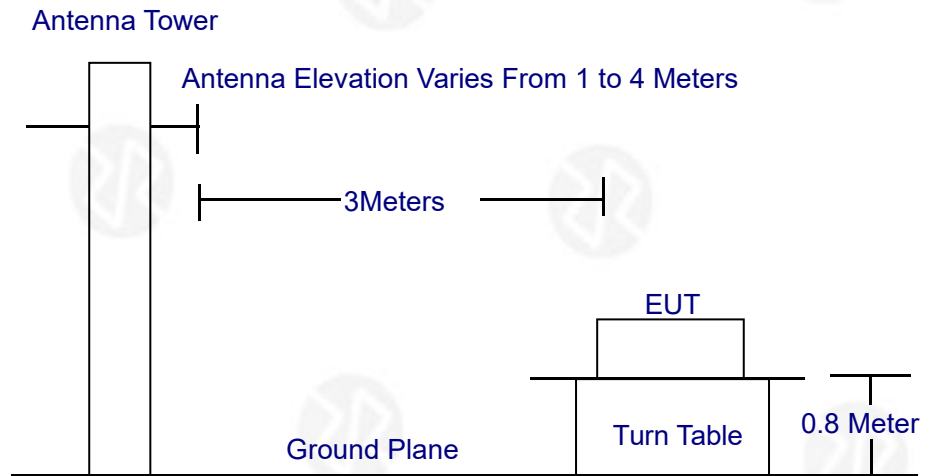

4.2 Test Standard

EN IEC 55014-1:2021

4.3 Radiation Limit

Frequency MHz	Distance (Meters)	Field Strengths Limits dB(μ V)/m
30 ~ 230	3	40.0
230 ~ 1000	3	47.0

Remark:

- (1) Emission level (dB(μ V)/m) = 20 log Emission level (μ V/m)
- (2) The smaller limit shall apply at the cross point between two frequency bands.
- (3) Distance refers to the distance in meters between the measuring instrument, antenna and the closed point of any part of the device or system.

4.4 EUT Configuration on Test

The EN IEC 55014-1 regulations test method must be used to find the maximum emission during radiated emission test.

The configuration of EUT is the same as used in conducted emission test.

Please refer to Section 2.2.

4.5 Operating Condition of EUT

Same as conducted emission test, which is listed in Section 2.2 except the test set up replaced as Section 4.1.



4.6 Test Procedure

The EUT and its simulators are placed on a turned table that is 0.8 meter above the ground. The turned table can rotate 360 degrees to determine the position of the maximum emission level. The EUT is set 3 meters away from the receiving antenna that is mounted on the antenna tower. The antenna can move up and down between 1 meter and 4 meters to find out the maximum emission level. Broadband antenna (calibrated biconical and log periodical antenna) is used as receiving antenna. Both horizontal and vertical polarization of the antenna is set on test. In order to find the maximum emission levels, the interface cable must be manipulated according to EN IEC 55014-1 on radiated emission test.

The bandwidth setting on the field strength meter (R&S Test Receiver ESCI) is set at 120KHz.

The frequency range from 30MHz to 1000MHz is checked.

4.7 Test Result

PASS

Please refer to the following page.



Radiation Emission Test Data			
Temperature:	24.5 °C	Relative Humidity:	54%
Pressure:	1009hPa	Phase :	Horizontal
Test Voltage :	DC 3.7V	Test Mode:	Working

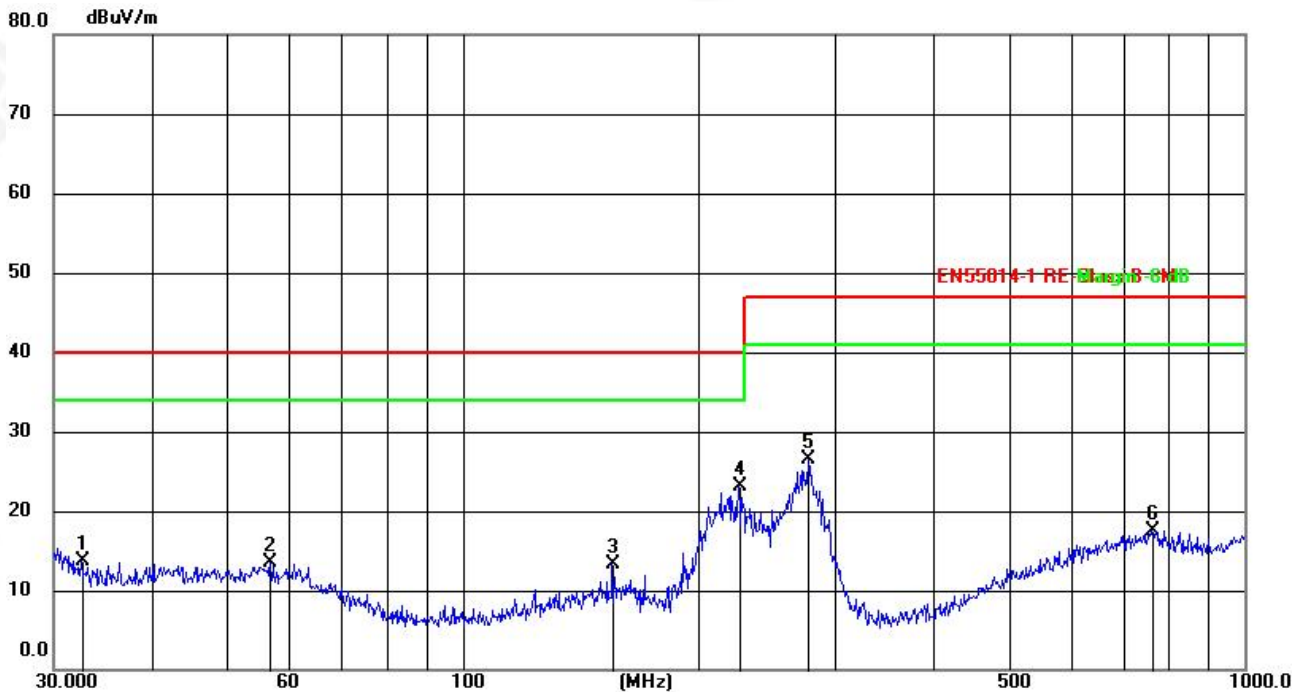

No.	Frequency (MHz)	Reading (dBuV)	Factor (dB/m)	Level (dBuV/m)	Limit (dBuV/m)	Margin (dB)	Detector
1	32.5198	29.57	-15.83	13.74	40.00	-26.26	QP
2	56.7917	28.93	-15.52	13.41	40.00	-26.59	QP
3	155.3644	32.05	-18.82	13.23	40.00	-26.77	QP
4	225.3080	43.95	-20.90	23.05	40.00	-16.95	QP
5	277.0935	45.18	-18.76	26.42	47.00	-20.58	QP
6	760.7036	30.41	-12.82	17.59	47.00	-29.41	QP

Notes:

1. An initial pre-scan was performed on the peak detector.
2. Quasi-Peak measurement were performed at the frequencies with maximized peak emission.
3. The emission levels of other frequencies are very lower than the limit and not show in test report.
4. Final Level = Reading level + Correct Factor
5. Correct Factor = Antenna factor + Cable loss factor - Amplifier factor
6. Margin = Measurement Level - Limit



Radiation Emission Test Data			
Temperature:	24.5 °C	Relative Humidity:	54%
Pressure:	1009hPa	Phase :	Vertical
Test Voltage :	DC 3.7V	Test Mode:	Working

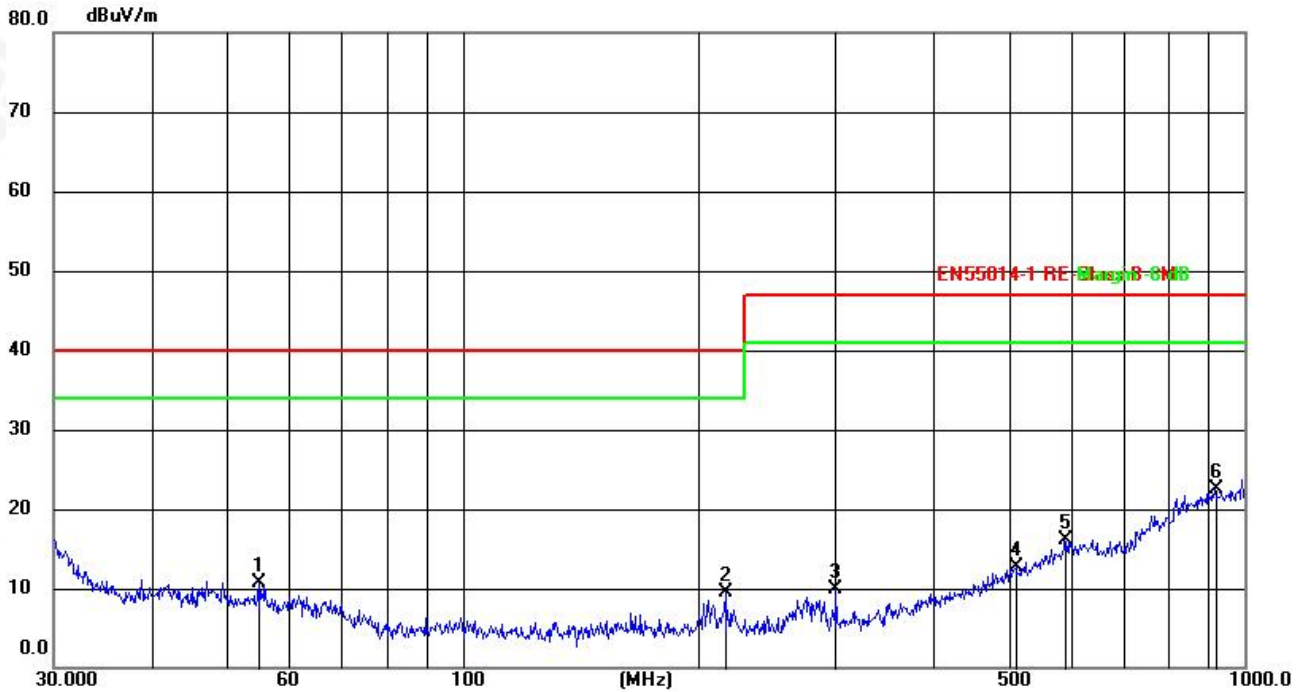

No.	Frequency (MHz)	Reading (dBuV)	Factor (dB/m)	Level (dBuV/m)	Limit (dBuV/m)	Margin (dB)	Detector
1	54.8348	29.90	-19.11	10.79	40.00	-29.21	QP
2	216.7828	33.35	-23.83	9.52	40.00	-30.48	QP
3	300.3672	32.71	-22.89	9.82	47.00	-37.18	QP
4	510.0436	28.98	-16.30	12.68	47.00	-34.32	QP
5	588.9051	29.64	-13.57	16.07	47.00	-30.93	QP
6	916.0687	29.58	-7.11	22.47	47.00	-24.53	QP

Notes:

- 1.An initial pre-scan was performed on the peak detector.
- 2.Quasi-Peak measurement were performed at the frequencies with maximized peak emission.
- 3.The emission levels of other frequencies are very lower than the limit and not show in test report.
- 4.Final Level = Reading level + Correct Factor
- 5.Correct Factor= Antenna factor+ Cable loss factor - Amplifier factor
- 6.Margin= Measurement Level-Limit



5. HARMONIC CURRENT EMISSION TEST

5.1 Block Diagram of Test Setup

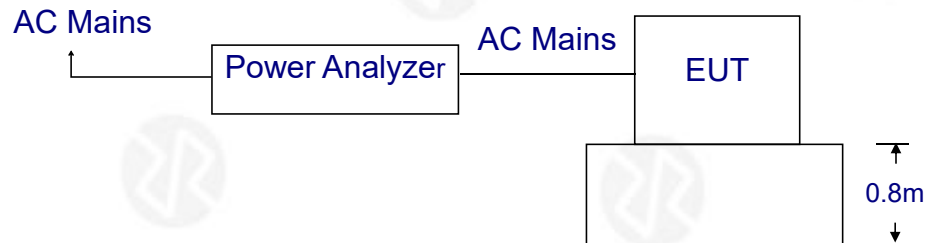

5.2 Test Standard

EN IEC 61000-3-2:2019/A1:2021/A2:2024

5.3 Operating Condition of EUT

- 5.3.1 Setup the EUT as shown in Section 5.1.
- 5.3.2 Turn on the power of all equipments.
- 5.3.3 Let the EUT work in test mode and test it.

5.4 Test Procedure

The power cord of the EUT is connected to the output of the test system. Turn on the power of the EUT and use the test system to test the harmonic current level.

5.5 Test Results

The EUT is powered by DC only. The test items is not applicable.



6. VOLTAGE FLUCTUATIONS & FLICKER TEST

6.1 Block Diagram of Test Setup

Same as Section 6.1.

6.2 Test Standard

EN 61000-3-3:2013/A1:2019/A2:2021

6.3 Operating Condition of EUT

Same as Section 5.3.. The power cord of the EUT is connected to the output of the test system. Turn on the power of the EUT and use the test system to test the harmonic current level.

Flicker Test Limit

Test items	Limits
Pst	1.0
dc	3.3%
Tmax	4.0%
dt	Not exceed 3.3% for 500ms

6.4 Test Procedure

The power cord of the EUT is connected to the output of the test system. Turn on the power of the EUT and use the test system to test the harmonic current level.

6.5 Test Results

The EUT is powered by DC only. The test items is not applicable.



7. ELECTROSTATIC DISCHARGE IMMUNITY TEST

7.1 Block Diagram of Test Setup

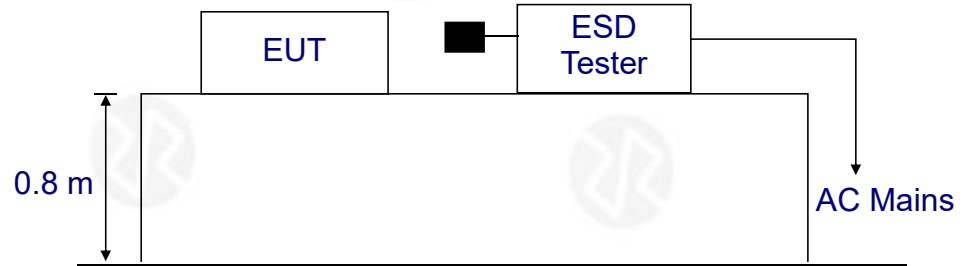

7.2 Test Standard

EN IEC 55014-2:2021, EN IEC 61000-4-2:2025

Severity Level: 3 / Air Discharge:±8KV
Level: 2 / Contact Discharge:±4KV

7.3 Severity Levels and Performance Criterion

7.3.1 Severity level

Level	Test Voltage Contact Discharge (KV)	Test Voltage Air Discharge (KV)
1.	±2	±2
2.	±4	±4
3.	±6	±8
4.	±8	±15
X	Special	Special

7.3.2 Performance criterion : B

- A. The apparatus shall continue to operate as intended during the test. No degradation of performance or loss of function is allowed below a performance level (or permissible loss of performance) specified by the manufacturer, when the apparatus is used as intended.
- B. The apparatus shall continue to operate as intended after the test. No degradation of performance or loss of function is allowed below a performance level (or permissible loss of performance) specified by the manufacturer, when the apparatus is used as intended. During the test, degradation of performance is allowed, however, no change of actual operating state or stored data is allowed. If the minimum performance level or the permissible performance loss is not specified by the manufacturer, then either of these may be derived from the product description and documentation, and from what the user may reasonably expect from the apparatus if used as intended.
- C. Temporary loss of function is allowed, provided the function is self-recoverable or can be restored by the operation of the controls, or by any operation specified in the instructions for use.



7.4 EUT Configuration

The following equipments are installed on Electrostatic Discharge Immunity test to meet EN IEC 55014-2:2021, EN IEC 61000-4-2:2025, requirement and operating in a manner which tends to maximize its emission characteristics in a normal application. The configuration of EUT is the same as used in conducted emission test. Please refer to Section 2.4.

7.5 Operating Condition of EUT

Same as conducted emission measurement, which is listed in Section 3.5 except the test setup replaced by Section 7.1.2.

7.6 Test Procedure

7.6.1 Air Discharge:

This test is done on a non-conductive surface. The round discharge tip of the discharge electrode shall be approached as fast as possible to touch the EUT. After each discharge, the discharge electrode shall be removed from the EUT. The generator is then re-triggered for a new single discharge and repeated 10 times for each pre-selected test point. This procedure shall be repeated until all the air discharge completed.

7.6.2 Contact Discharge:

All the procedure shall be same as Section 7.6.1. Except that the tip of the discharge electrode shall touch the EUT before the discharge switch is operated.

7.6.3 Indirect discharge for horizontal coupling plane

At least 10 single discharges (in the most sensitive polarity) shall be applied at the front edge of each HCP opposite the center point of each unit (if applicable) of the EUT and 0.1m from the front of the EUT. The long axis of the discharge electrode shall be in the plane of the HCP and perpendicular to its front edge during the discharge.

7.6.4 Indirect discharge for vertical coupling plane

At least 10 single discharges (in the most sensitive polarity) shall be applied to the center of one vertical edge of the coupling plane. The coupling plane, of dimensions 0.5m X 0.5m, is placed parallel to, and positioned at a distance of 0.1m from the EUT. Discharges shall be applied to the coupling plane, with this plane in sufficient different positions that the four faces of the EUT are complete illuminated.

7.7 Test Results

PASS

Please refer to the following page.



ESD Test Data				
Temperature:	24.5°C	Humidity:	53%	
Power Supply :	DC 3.7V	Test Mode:	On	
Air Discharge: ± 8KV Contact Discharge: ± 4KV				
Test Points	Air Discharge	Contact Discharge	Performance Criterion	Result
Enclosure	±2,4,8KV	N/A	B	PASS
Slit	±2,4,8KV	N/A	B	PASS
Metal Part	N/A	±2,4 KV	B	PASS
VCP	N/A	±2,4 KV	B	PASS
HCP	N/A	±2,4 KV	B	PASS
Note: N/A				



8. RF FIELD STRENGTH SUSCEPTIBILITY TEST

8.1 Block Diagram of Test Setup

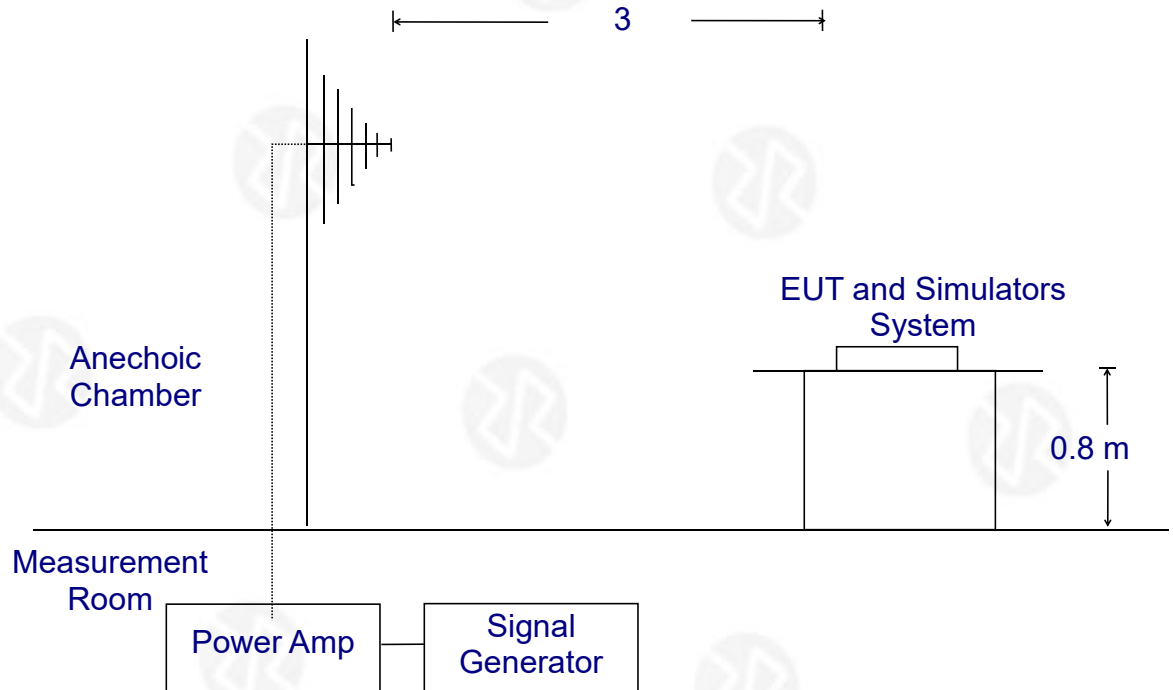

8.2 Test Standard

EN IEC 55014-2:2021,
EN IEC 61000-4-3:2020

Severity Level 2, 3V / m

8.3 Severity Levels and Performance Criterion

8.3.1. Severity level

Level	Field Strength V/m
1.	1
2.	3
3.	10
X.	Special



8.3.2. Performance criterion: A

- A、 The apparatus shall continue to operate as intended during the test. No degradation of performance or loss of function is allowed below a performance level (or permissible loss of performance) specified by the manufacturer, when the apparatus is used as intended.
- B、 The apparatus shall continue to operate as intended after the test. No degradation of performance or loss of function is allowed below a performance level (or permissible loss of performance) specified by the manufacturer, when the apparatus is used as intended. During the test, degradation of performance is allowed, however, no change of actual operating state or stored data is allowed. If the minimum performance level or the permissible performance loss is not specified by the manufacturer, then either of these may be derived from the product description and documentation, and from what the user may reasonably expect from the apparatus if used as intended.
- C、 Temporary loss of function is allowed, provided the function is self- recoverable or can be restored by the operation of the controls, or by any operation specified in the instructions for use.

8.4 EUT Configuration on Test

The following equipments are installed on Electrical Fast Transient/Burst Immunity test to meet EN IEC 55014-2:2021, EN 61000-4-4:2012, requirement and operating in a manner which tends to maximize its emission characteristics in a normal application. The configuration of EUT is the same as used in conducted emission test. Please refer to Section 3.4.

8.5 Operating Condition of EUT

Same as conducted emission measurement, which is listed in Section 2.5 except the test setup replaced by Section 8.1.

8.6 Test Procedure

The EUT and its simulators are placed on a turn table which is 0.8 meter above ground. EUT is set 3 meter away from the transmitting antenna which is mounted on an antenna tower. Both horizontal and vertical polarization of the antenna are set on test. Each of the four sides of EUT must be faced this transmitting antenna and measured individually.

All the scanning conditions are as follows :

Condition of Test	Remarks
1. Fielded Strength	3 V/m (Severity Level 2)
2. Radiated Signal	Modulated
3. Scanning Frequency	80 – 1000 MHz
4. Dwell time of radiated	0.0015 decade/s
5. Waiting Time	1 Sec.

8.7 Test Results

PASS

Please refer to the following page.



R/S Test Data			
Temperature : 25°C		Humidity : 53%	
Field Strength: 3 V/m		Criterion: A	
Power Supply: DC 3.7V		Frequency Range: 80 MHz to 1000 MHz	
Modulation: <input checked="" type="checkbox"/> AM <input type="checkbox"/> Pulse <input type="checkbox"/> none 1 KHz 80%			
Test Mode : On			
Frequency Range : 80-1000MHz			
Steps 1 %			
	Horizontal	Vertical	Result
Front	A	A	Pass
Right	A	A	Pass
Rear	A	A	Pass
Left	A	A	Pass
Note: The EUT is the testing item(s) was (were) fulfilled by subcontracted lab SHENZHEN HAIYUN TESTING CO.,LTD			



9. ELECTRICAL FAST TRANSIENT/BURST IMMUNITY TEST

9.1 Block Diagram of EUT Test Setup



9.2 Test Standard

EN IEC 55014-2:2021, EN 61000-4-4:2012

9.3 Severity Levels and Performance Criterion

Severity Level 2 at 1KV, Pulse Rise time & Duration: 5 nS / 50 nS

Severity Level:

Level	Open Circuit Output Test Voltage $\pm 10\%$	
	On power ports	On I/O(Input/Output) Signal data and control ports
1.	0.5KV	0.25KV
2.	1KV	0.5KV
3.	2KV	1KV
4.	4KV	2KV
X.	Special	Special

Performance criterion: B

- A. The apparatus shall continue to operate as intended during the test. No degradation of performance or loss of function is allowed below a performance level (or permissible loss of performance) specified by the manufacturer, when the apparatus is used as intended.
- B. The apparatus shall continue to operate as intended after the test. No degradation of performance or loss of function is allowed below a performance level (or permissible loss of performance) specified by the manufacturer, when the apparatus is used as intended. During the test, degradation of performance is allowed, however, no change of actual operating state or stored data is allowed. If the minimum performance level or the permissible performance loss is not specified by the manufacturer, then either of these may be derived from the product description and documentation, and from what the user may reasonably expect from the apparatus if used as intended.
- C. Temporary loss of function is allowed, provided the function is self-recoverable or can be restored by the operation of the controls, or by any operation specified in the instructions for use.



9.4 EUT Configuration on Test

The following equipments are installed on Electrical Fast Transient/Burst Immunity test to meet EN IEC 55014-2:2021, EN 61000-4-4:2012, requirement and operating in a manner which tends to maximize its emission characteristics in a normal application. The configuration of EUT is the same as used in conducted emission test. Please refer to Section 3.4.

9.5 Operating Condition of EUT

Same as conducted emission measurement, which is listed in Section 2.6 except the test setup replaced by Section 9.1.

9.6 Test Procedure

EUT shall be placed 0.8m high above the ground reference plane which is a min.1m*1m metallic sheet with 0.65mm minimum thickness. This reference ground plane shall project beyond the EUT by at least 0.1m on all sides and the minimum distance between EUT and all other conductive structure, except the ground plane beneath the EUT, shall be more than 0.5m

9.6.1. For input and output AC power ports:

The EUT is connected to the power mains by using a coupling device which couples the EFT interference signal to AC power lines. Both polarities of the test voltage should be applied during compliance test and the duration of the test is 2 minutes.

9.7 Test Results

The EUT is powered by DC only. The test items is not applicable.



10. SURGE TEST

10.1 Block Diagram of EUT Test Setup



10.2 Test Standard

EN IEC 55014-2:2021, EN 61000-4-5:2014/A1:2017

10.3 Severity Levels and Performance Criterion

Severity Level: Line to Line, Level 2 at 1KV;

Severity Level: Line to Earth, Level 3 at 2KV.

Severity Level	Open-Circuit Test Voltage (KV)
1.	0.5
2.	1.0
3.	2.0
4.	4.0
X.	Special

Performance criterion: B

- A. The apparatus shall continue to operate as intended during the test. No degradation of performance or loss of function is allowed below a performance level (or permissible loss of performance) specified by the manufacturer, when the apparatus is used as intended.
- B. The apparatus shall continue to operate as intended after the test. No degradation of performance or loss of function is allowed below a performance level (or permissible loss of performance) specified by the manufacturer, when the apparatus is used as intended. During the test, degradation of performance is allowed, however, no change of actual operating state or stored data is allowed. If the minimum performance level or the permissible performance loss is not specified by the manufacturer, then either of these may be derived from the product description and documentation, and from what the user may reasonably expect from the apparatus if used as intended.
- C. Temporary loss of function is allowed, provided the function is self-recoverable or can be restored by the operation of the controls, or by any operation specified in the instructions for use.



10.4 EUT Configuration on Test

The following equipments are installed on Electrical Fast Transient/Burst Immunity test to meet EN IEC 55014-2:2021, EN 61000-4-5:2014/A1:2017, requirement and operating in a manner which tends to maximize its emission characteristics in a normal application

The configuration of EUT is the same as used in conducted emission test.
Please refer to Section 3.4.

10.5 Operating Condition of EUT

Same as conducted emission measurement, which is listed in Section 2.7 except the test setup replaced by Section 10.1.

10.6 Test Procedure

- 1) Set up the EUT and test generator as shown on section 10.1
- 2) For line to line coupling mode, provide a 1KV 1.2/50us voltage surge (at open-circuit condition) and 8/20us current surge to EUT selected points.
- 3) At least 5 positive and 5 negative (polarity) tests with a maximum 1/min repetition rate are conducted during test.
- 4) Different phase angles are done individually.
- 5) Repeat procedure 2) to 4) except the open-circuit test voltage change from 1KV to 2KV for line to earth coupling mode test.
- 6) Record the EUT operating situation during compliance test and decide the EUT immunity criterion for above each test.

10.7 Test Result

The EUT is powered by DC only. The test items is not applicable.



11. INJECTED CURRENTS SUSCEPTIBILITY TEST

11.1 Block Diagram of EUT Test Setup

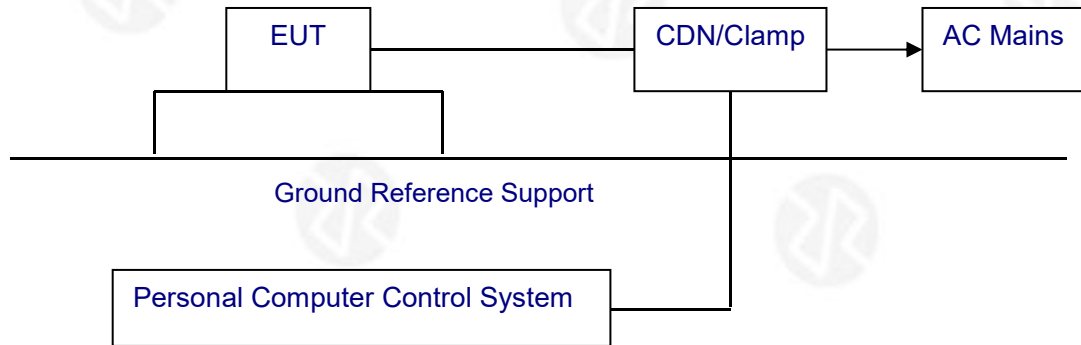

11.2 Test Standard

EN IEC 55014-2:2021, EN IEC 61000-4-6:2023

11.3 Severity Levels and Performance Criterion

Severity Level 2: 3V(rms), 150KHz ~ 80MHz

Severity Level:

Level	Field Strength V
1.	1
2.	3
3.	10
X.	Special

Performance criterion: A

- A. The apparatus shall continue to operate as intended during the test. No degradation of performance or loss of function is allowed below a performance level (or permissible loss of performance) specified by the manufacturer, when the apparatus is used as intended.
- B. The apparatus shall continue to operate as intended after the test. No degradation of performance or loss of function is allowed below a performance level (or permissible loss of performance) specified by the manufacturer, when the apparatus is used as intended. During the test, degradation of performance is allowed, however, no change of actual operating state or stored data is allowed. If the minimum performance level or the permissible performance loss is not specified by the manufacturer, then either of these may be derived from the product description and documentation, and from what the user may reasonably expect from the apparatus if used as intended.
- C. Temporary loss of function is allowed, provided the function is self-recoverable or can be restored by the operation of the controls, or by any operation specified in the instructions for use.

11.4 EUT Configuration on Test

The configuration of EUT is the same as used in conducted emission test.
Please refer to Section 2.8.



11.5 Operating Condition of EUT

Same as conducted emission test, which is listed in Section 2.8 except the test set up replaced as Section 11.1.

11.6 Test Procedure

- 1) Set up the EUT, CDN and test generator as shown on section 11.1
- 2) Let EUT work in test mode and measure.
- 3) The EUT and supporting equipments are placed on an insulating support 0.1m high above a ground reference plane. CDN (coupling and decoupling device) is placed on the ground plane at above 0.1-0.3m from EUT. Cables between CDN and EUT are as short as possible, and their height above the ground reference plane shall be between 30 and 50 mm (where possible).
- 4) The disturbance signal described below is injected to EUT through CDN.
- 5) The EUT operates within its operational mode(s) under intended climatic conditions after power on.
- 6) The frequency range is swept from 150KHz to 80MHz using 3V signal level, and with the disturbance signal 80% amplitude modulated with a 1KHz sine wave
- 7) The rate of sweep shall not exceed 1.5×10^{-3} decades/s. Where the frequency is swept incrementally, the step size shall not exceed 1% of the start and thereafter 1% of the preceding frequency value.
- 8) Recording the EUT operating situation during compliance test and decide the EUT immunity criterion for above each test.

11.7 Test Result

The EUT is powered by DC only. The test items is not applicable.



12. VOLTAGE DIPS AND INTERRUPTIONS TEST

12.1 Block Diagram of EUT Test Setup



12.2 Test Standard

EN IEC 55014-2:2021, EN IEC 61000-4-11:2020

12.3 Severity Levels and Performance Criterion

Severity Level:

Input and Output AC Power Ports.

- Voltage Dips.
- Voltage Interruptions.

Environmental Phenomena	Test Specification	Units	Performance Criterion
Voltage Dips	70	% Reduction period	C
	25		
	40	% Reduction period	C
	10		
Voltage Interruptions	0	% Reduction period	C
	0.5		

Performance criterion: B, C, C

- A. The apparatus shall continue to operate as intended during the test. No degradation of performance or loss of function is allowed below a performance level (or permissible loss of performance) specified by the manufacturer, when the apparatus is used as intended.
- B. The apparatus shall continue to operate as intended after the test. No degradation of performance or loss of function is allowed below a performance level (or permissible loss of performance) specified by the manufacturer, when the apparatus is used as intended. During the test, degradation of performance is allowed, however, no change of actual operating state or stored data is allowed. If the minimum performance level or the permissible performance loss is not specified by the manufacturer, then either of these may be derived from the product description and documentation, and from what the user may reasonably expect from the apparatus if used as intended.
- C. Temporary loss of function is allowed, provided the function is self-recoverable or can be restored by the operation of the controls, or by any operation specified in the instructions for use.



12.4 EUT Configuration on Test

The configuration of EUT is the same as used in conducted emission test.
Please refer to Section 2.10.

12.5 Operating Condition of EUT

Same as conducted emission test, which is listed in Section 2.10 except the test set up replaced as Section 13.1.

12.6 Test Procedure

- 1) Set up the EUT and test generator as shown on section 13.1
- 2) The interruption is introduced at selected phase angles with specified duration. There is a 3mins minimum interval between each test event.
- 3) After each test a full functional check is performed before the next test.
- 4) Repeat procedures 2 & 3 for voltage dips, only the level and duration is changed.
- 5) Record any degradation of performance.

12.7 Test Result

The EUT is powered by DC only. The test items is not applicable.



13. EUT PHOTOGRAPHS

EUT Photo 1

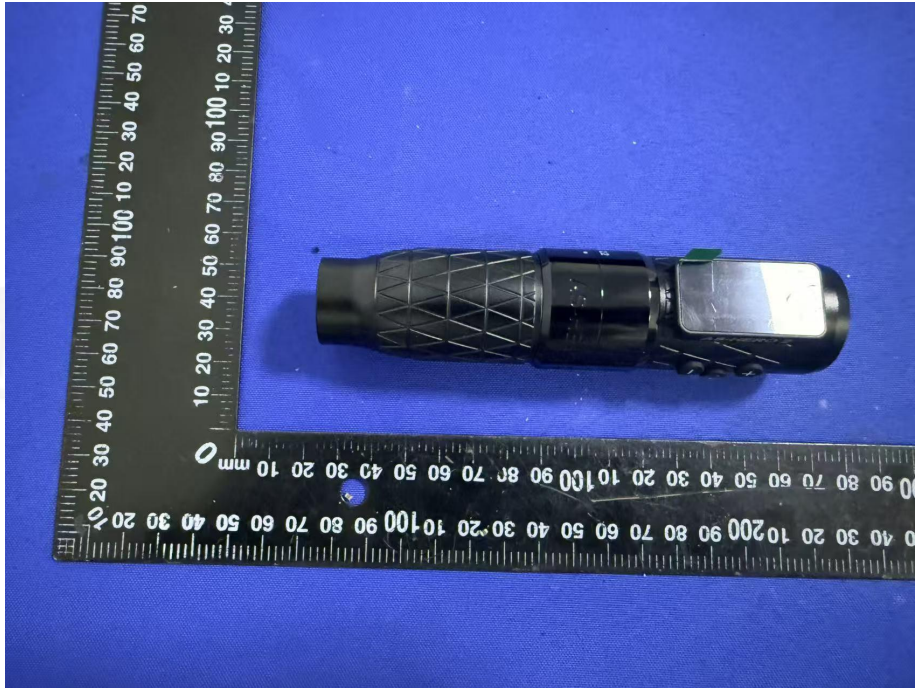

EUT Photo 2





EUT Photo 3



EUT Photo 4





EUT Photo 5

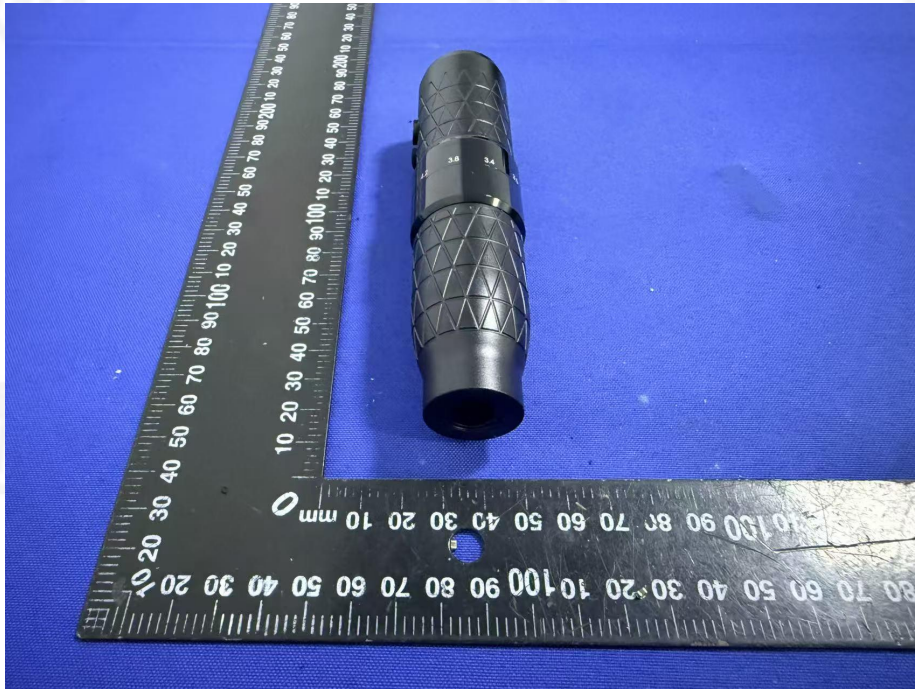

EUT Photo 6

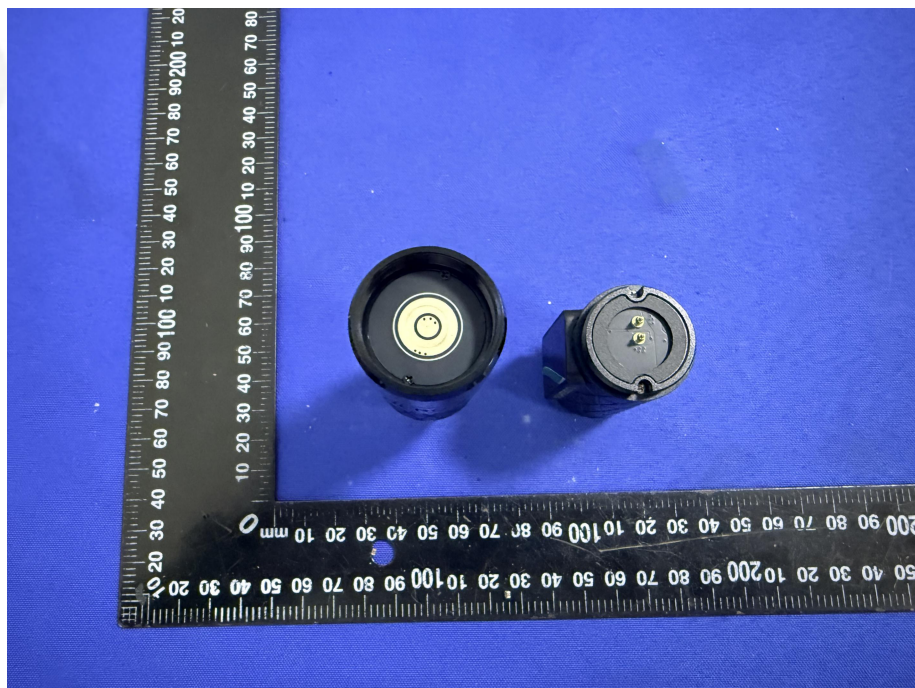



EUT Photo 7

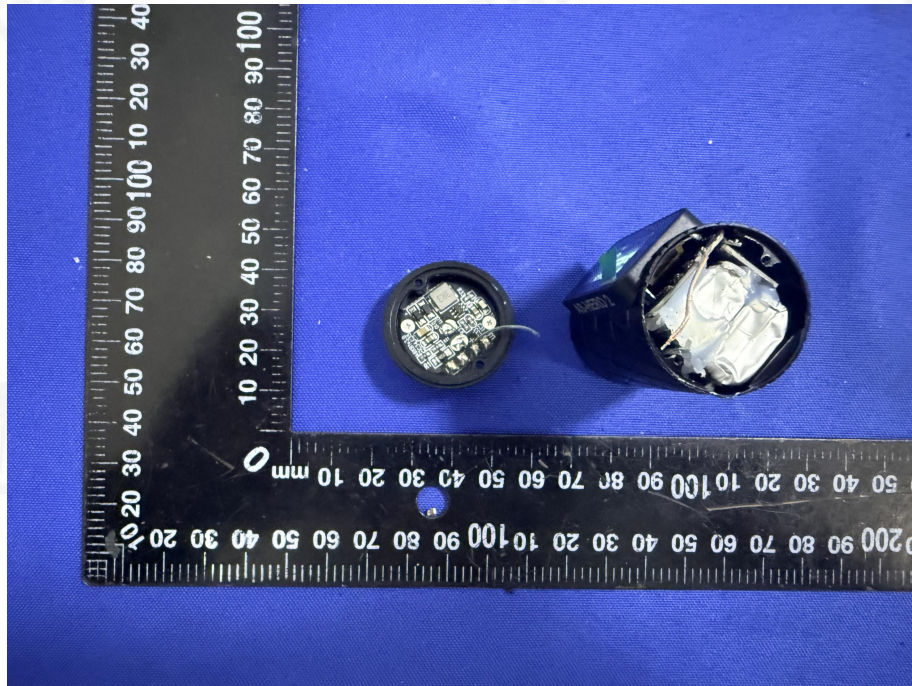



14. EUT TEST PHOTOGRAPHS

RE

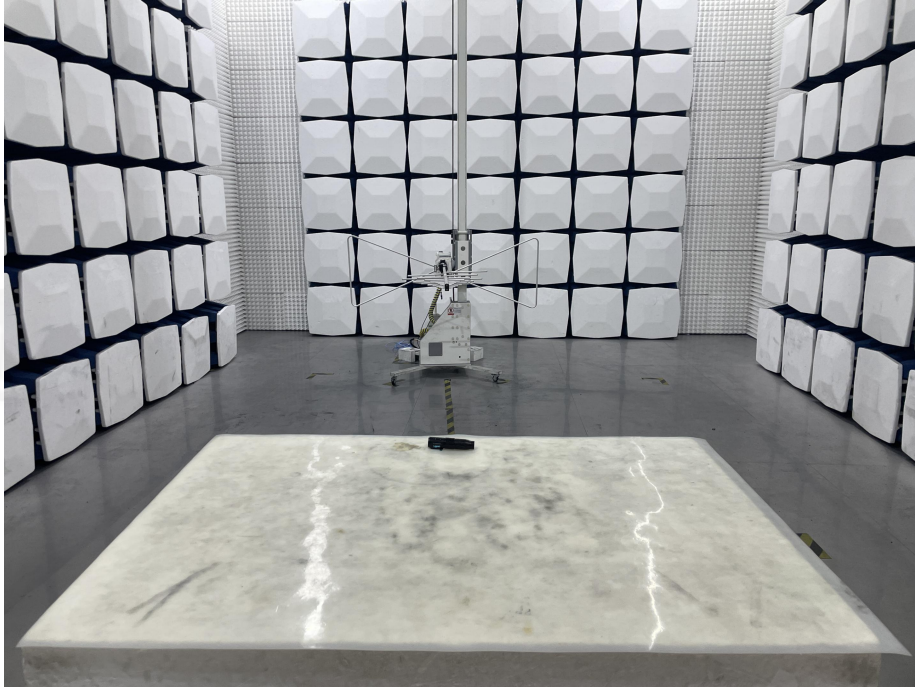

***** END OF REPORT *****